



Film Capacitors – PFC

Installation and maintenance instructions for capacitor contactors

Series/Type:	Capacitor Contactors
Ordering code:	B44066S....J110/J230/N230/N110
Date:	October 2010
Version:	2

Installation and maintenance instructions

Read this first!

Read the following »Installation and Maintenance Instructions« carefully before installing a capacitor contactor into your application.

About this manual

The information stated in this manual applies to typical, approved usage. Please refer to our product specifications, or request our approval for your own individual specifications, before installing contactors.

For detailed information about PFC key components and cautions, refer to the latest version of EPCOS PFC Product Profile.

Technical data

For detailed technical data about capacitor contactors, please refer to the datasheet, available in the EPCOS-Internet.

For your safety!

Disregarding the guidelines in this manual can result in operational failure, bursting and fire. In case of doubt, contact your local EPCOS sales organization or distributor for assistance.

General safety notes for installation and operation

- Ensure you are using the right contactor type for your application. Please refer to the EPCOS product catalog and application notes for proper selection of contactors. Please contact EPCOS for any assistance required in selection.
- Maintain good, effective grounding of capacitor enclosures.

Usage of contactors without pre-charge resistors

- Capacitor contactors type N230 do not feature pre-charge resistors and may only be used in de-tuned PFC-systems (with reactors)!

Storage and operation conditions

- Do not use or store contactors in a corrosive atmosphere, especially where chloride gas, sulfide gas, acid, alkali, salt or similar substances are present. In a dusty environment, regular maintenance and cleaning, is required.
- In the area of capacitor switching contactors, difficultly inflammable and self-extinguishing materials may be used only, because abnormal temperatures within the area of the resistance spirals cannot be excluded

Caution!

Contactors should not be installed or used in case of mechanical or any other kind of damage!

Selection of the contactor type

Apart from the selection of J-types for conventional PFC-systems without reactors or N-types for de-tuned systems with reactor, following criteria have to be considered for selection of the right capacitor contactor.

1) Selection of load current

It should be taken into consideration that the current increases when there is harmonic contents in the system. When the conductors are dimensioned in the factory, a particular overload factor was considered. This factor is the reserve between the capacitor current (I_e AC6b) to the thermal current ($I_{th} = I_e$ AC1). See table shown below.

B44066S....J230/J110/N230/N110			S1810	S2410	S3210	S5010	S6210	S7410	S9010	S9910
Rated operational current I_e AC6b	at 50 °C	A	0-18	14-28	14-36	30-48	30-72	30-108	50-115	50-144
	at 60 °C	A	0-18	14-28	14-36	30-48	30-72	30-87	50-108	50-130
Rated operation current I_{th} I_e AC1	at 50 °C	A	32	45	60	100	110	120	155	190
	at 60 °C	A	32	40	55	90	100	110	145	170
Overload factor Acc. to EN 61921: 30 % min.	at 50 °C	%	78	60	67	108	53	11	35	32
	at 60 °C	%	78	43	53	88	39	26	34	31

2) Supply cables

The terminals are exclusively designed for connection with copper cables only (Cu-EPT-99.9% copper). While selecting the thermal load it has to be considered that the cables connected to the terminal are not damaged at the max. increase of 70 Kelvin at the terminal (acc. to IEC 60947).

The ambient temperature has to be considered as well.

3) Selection of cable cross sections acc. to table 9 (IEC 60947-1)

Current A (max)	Cable cross section	
	mm ²	AWG
12	1.5	16
15	2.5	14
20	2.5	12
25	4	10
32	6	10
50	10	8
65	16	6
85	25	4
100	35	3
115	35	2
139	50	1
150	50	0

The selected minimum cable cross section is typically larger than the cross section specified according to the maximum current carrying capability acc. to the way of installation.

Film capacitors - PFC

Installation and maintenance instructions for capacitor contactors

4) Selection of cable cross sections => several cables into one terminal

Consider:

In that case the terminal has to be suitable for the current carrying capacity based on the total amount of all the cable cross sections, and not based on the total amount of each single cable current carrying capacity.

For example:

10mm ² cable	= max 50 A
2,5mm ² cable	= max 20 A
4x 2.5mm ² cables = 10mm ²	≠ 4x 20 A → max. 80 A = max. 50 A

5) Preparation of cables

Consider when wiring with unprepared cables:

- that all strands are fixed together in the terminal (otherwise loss of cable diameter, danger of short circuits)

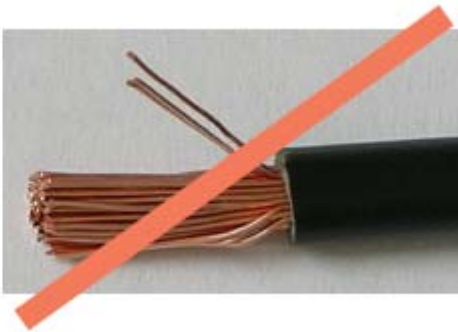

- soldering of the strands is prohibited (reduction of tightening torque, danger of overheating)
- right cable strip length, see chapter 6
- insulation must not be clamped into terminal (reduction of tightening torque, danger of overheating)



Film capacitors - PFC

Installation and maintenance instructions for capacitor contactors

Consider at wiring with multi-core cable end:

- right cable strip length, see chapter 6
- right crimping tool

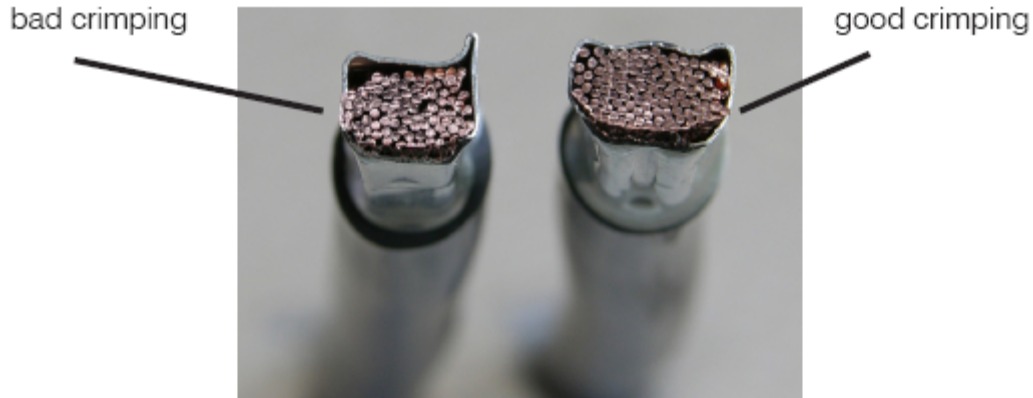

Note: Good crimping means the homogenous split of strands and same amount of the connections to the sides with equal pressure.

- Insulation must not be clamped into terminal (reduction of tightening torque, danger of overheating)

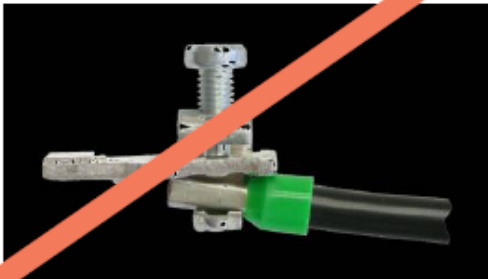

6) Cable strip length

Consider the recommended cable strip length, indicated on the contactor!

Contactors	S1810	S2410, S3210	S5010, S6210, S7410	S9010, S9910
Cable strip length	11 mm	13 mm	20 mm	25 mm

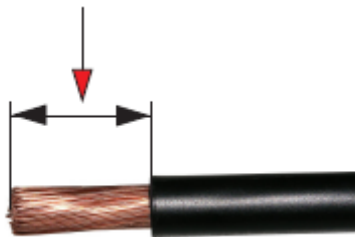

Film capacitors - PFC

Installation and maintenance instructions for capacitor contactors

7) Use of more parallel cables without multi-core cable end is o.k.

Ratings for 2 cables per clamp see at table, ratings for more than 2 cables on request.

6+(1,5-4) means 1 cable 6 mm ² + 1 cable 1,5 mm ² or 1 cable 6 mm ² + 1 cable 2,5 mm ² or 1 cable 6 mm ² + 1 cable 4 mm ²		Contactors S1810	Contactors S2410 S3210	Contactors S5010 S6210 S7410	Contactors S9010 S9910
solid or stranded	mm ²	6+(1-6) 4+(0,75-4) 2,5+(0,75-2,5) 1,5+(0,75-1,5)	16+(2,5-16) 10+(4-16) 6+(4-16) 4+(2,5-16)	50+4 35+6 25+(6-16) 16+(6-16)	0,5-95 + 10-120
flexible	mm ²	6+(1,5-4) 4+(1-4) 2,5+(0,75-2,5) 1,5+(0,75-1,5)	16+(2,5-6) 10+(4-10) 6+(4-16) 4+(2,5-16)	50+(4-10) 35+(4-16) 25+(4-25) 16+(4-16)	0,5-70 + 10-95
solid	AWG	10+(16-10) 12+(18-12) 14+(18-14)	10+(16-10) 12+(18-12) 14+(18-14) 16+(18-16)	10+(12-10) 12+12	20-10
flexible	AWG	10+(14-10) 12+(18-12) 14+(18-14) 16+(18-16)	4+(18-12) 6+(18-8) 8+(18-8) 10+(18-12)	1+(12-10) 2+(8-12) 3+(12-8) 4+(10-6)	20-2/0 + 8-2/0

8) Use of two or more wires in one multi-core cable end

- 2 wires... suitable, with special multi-core cable end and crimping tool













- 3 or more wires... not suitable, because no standard multi-core cable end and crimping tools are available. For example: 3 x 10 mm² = 30 mm² ... next multi-core cable end: 35mm²

Film capacitors - PFC

Installation and maintenance instructions for capacitor contactors

9) Tightening torque for terminal screws

Device Type	Kind of connection				Screw driver		Tightening torque	
	Screw with washer	Screw with clamp box	Screw with nut		standard	special	Nm	lb inch
								
Contactors								
Main terminals								
S1810	M3.5	-	-	-		Pz2 Tx15	0.8 - 1.4	7 - 12
S2410, S3210	-	M5	-	-		Pz2 Tx30	2.5 - 3	22 - 28
S5010, S6210, S7410	-	M6	-	-		Pz3 Tx30	3.5 - 4.5	31 - 40
S9010, S9910	-	-	M8	-		4 mm hex socket	4 - 6.5	35 - 57
Auxiliary terminals								
S1810	M3.5	-	-	-		Pz2 Tx15	0.8 - 1.4	7 - 12
Coil terminals								
S1810...S9910	M3.5	-	-	-		Pz2 Tx15	0.8 - 1.4	7 - 12

Retightening of terminal screws is recommended but not mandatory.

10) Selection of control voltage

Contactors	S1810	S2410, S3210	S5010, S6210, S7410	S9010, S9910
Power consumption of coils				
AC operated inrush VA	33-45	90-115	140-165	190-280
sealed VA	7-10	9-13	13-18	2.5-5
W	2.6-3	2.7-4	5.4-7	2.5-5

While dimensioning control transformers, please consider the inrush currents of contactors.

11) Mounting position

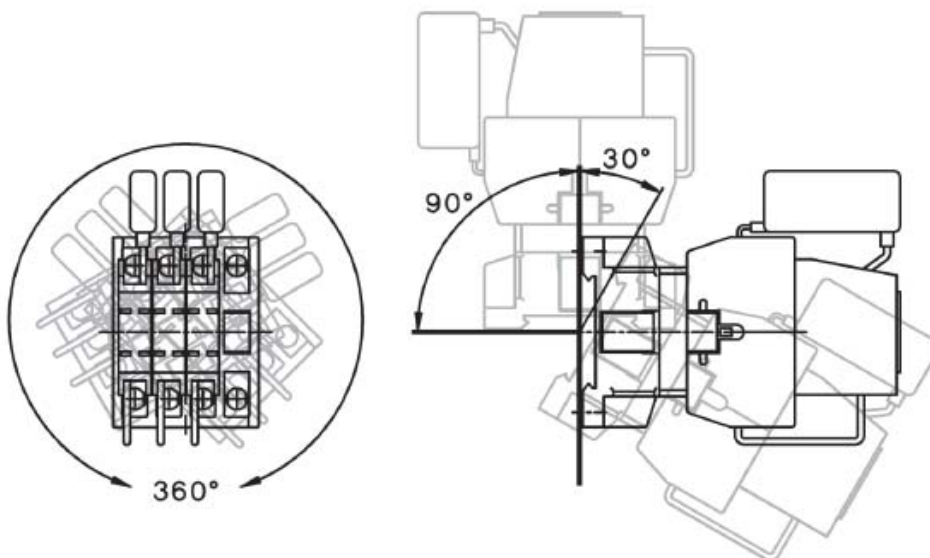

Important notes

The following applies to all products named in this publication:

1. Some parts of this publication contain **statements about the suitability of our products for certain areas of application**. These statements are based on our knowledge of typical requirements that are often placed on our products in the areas of application concerned. We nevertheless expressly point out **that such statements cannot be regarded as binding statements about the suitability of our products for a particular customer application**. As a rule, EPCOS is either unfamiliar with individual customer applications or less familiar with them than the customers themselves. For these reasons, it is always ultimately incumbent on the customer to check and decide whether an EPCOS product with the properties described in the product specification is suitable for use in a particular customer application.
2. We also point out that **in individual cases, a malfunction of electronic components or failure before the end of their usual service life cannot be completely ruled out in the current state of the art, even if they are operated as specified**. In customer applications requiring a very high level of operational safety and especially in customer applications in which the malfunction or failure of an electronic component could endanger human life or health (e.g. in accident prevention or life-saving systems), it must therefore be ensured by means of suitable design of the customer application or other action taken by the customer (e.g. installation of protective circuitry or redundancy) that no injury or damage is sustained by third parties in the event of malfunction or failure of an electronic component.
3. **The warnings, cautions and product-specific notes must be observed.**
4. In order to satisfy certain technical requirements, **some of the products described in this publication may contain substances subject to restrictions in certain jurisdictions (e.g. because they are classed as hazardous)**. Useful information on this will be found in our Material Data Sheets on the Internet (www.epcos.com/material). Should you have any more detailed questions, please contact our sales offices.
5. We constantly strive to improve our products. Consequently, **the products described in this publication may change from time to time**. The same is true of the corresponding product specifications. Please check therefore to what extent product descriptions and specifications contained in this publication are still applicable before or when you place an order. We also **reserve the right to discontinue production and delivery of products**. Consequently, we cannot guarantee that all products named in this publication will always be available. The aforementioned does not apply in the case of individual agreements deviating from the foregoing for customer-specific products.
6. Unless otherwise agreed in individual contracts, **all orders are subject to the current version of the "General Terms of Delivery for Products and Services in the Electrical Industry" published by the German Electrical and Electronics Industry Association (ZVEI)**.
7. The trade names EPCOS, BAOKE, Alu-X, CeraDiode, CSMP, CSSP, CTVS, DeltaCap, DigiSiMic, DSSP, MiniBlue, MiniCell, MKK, MLSC, MotorCap, PCC, PhaseCap, PhaseCube, PhaseMod, PhiCap, SIFERRIT, SIFI, SIKOREL, SilverCap, SIMDAD, SiMic, SIMID, SineFormer, SIOV, SIP5D, SIP5K, ThermoFuse, WindCap are **trademarks registered or pending** in Europe and in other countries. Further information will be found on the Internet at www.epcos.com/trademarks.