



Inductors

General technical information

Date: October 2008

General technical information

1 Inductive components for electronic equipment

Inductive components store energy intermittently in switch-mode power supplies and DC/DC converters, form parts of RF circuits or RFID systems, match impedances, transform current/voltage, are filter elements and last but not least interference suppression components to ensure EMC.

The requirements on inductors depend on how and where they are used. RF circuits need coils with high quality factors and resonant frequencies. EMC applications require high inductance to achieve good interference suppression characteristics, low Q factors being more desirable here due to the need to avoid resonance.

EPCOS provides suitable inductive components for all applications. This data book contains a wide selection of standard components, from SMT types (starting with SIMID 0402) through 4-line high-current inductors for power electronics applications to transformers.

Attention is drawn to the excellent RF characteristics and extremely high reliability of the components, achieved by large-scale production automation and many years of experience in the manufacture of this kind of component.

2 Typical applications for inductors and chokes

Application	Inductance	Current rating	Resonance frequency	Q factor	DC resistance
RF circuits, resonant circuits	low	low	very high	very high	low
EMC	high	high	high	low	very low
RFID	*	low	high	high	low
DC/DC converters	*	high	medium	high	low
Transformers in DC/DC	*	*	medium	*	low
Signal processing	*	low	high	—	medium

* depends on the specific application

2.1 RF circuits

The SIMID product range and leaded RF chokes are especially suitable for RF and other high-frequency circuits. Typical applications are resonant circuits and frequency-selective filters of the type increasingly used in telecommunications engineering and automotive electronics.

EPCOS also offers double-aperture transformers for use as directional couplers and splitters.

2.2 Filter circuits

When inductive components are used for filters in power supplies for electronics, high inductance, the lowest possible DC resistance and a low Q factor are required. The impedance should have a wideband frequency characteristic. In addition to the current rating, the maximum permissible pulse current (switching transient currents) and adequately high core material saturation are of importance.

Chokes of all type series presented here can be used for this range of applications, from the SIMID types right up to chokes with powder cores and one or two lines.

2.3 RFID systems

RFID systems allow contactless identification without direct line-of-sight contact. They are used for wireless data transmission in a range of a few meters. Examples of their application include the automobile industry, logistics, agriculture, medical engineering and security systems.

The range of EPCOS transponder coils is especially designed for high mechanical stability and high sensitivity as required in the automobile industry for immobilizers, car access systems and tire pressure monitoring systems (TPMS).

2.4 Switch-mode power supplies, DC/DC converters

Inductive components are used for magnetic energy storage in all kinds of switch-mode power supplies and DC/DC converters.

Depending on application, a broad range of different components starting from high-current SIMID and SMT power inductors up to toroid chokes and transformers can be used.

Overview

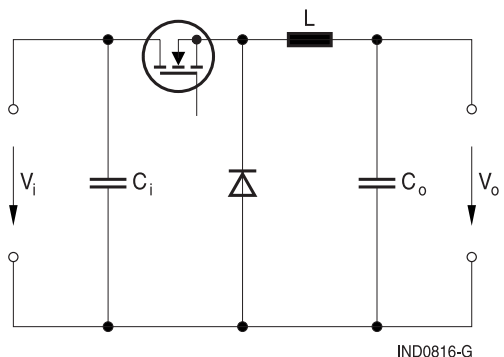
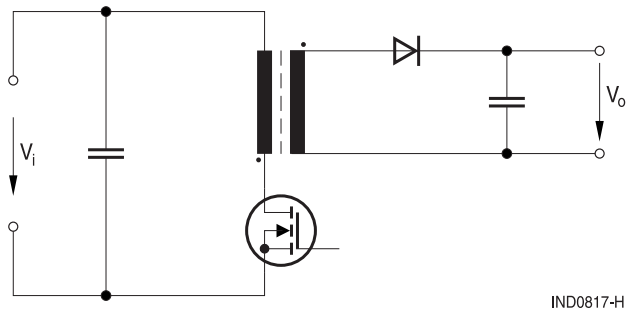
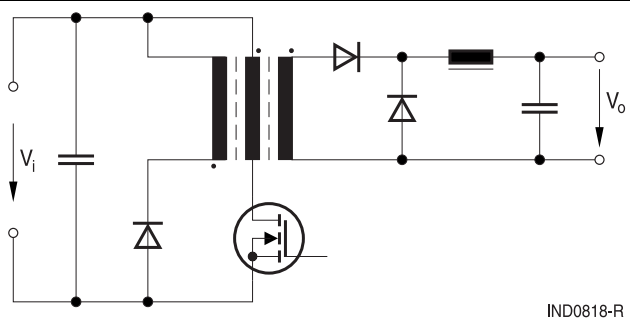
Application	Typical circuit diagram	Components
Step-down converters		<ul style="list-style-type: none"> ■ Ring core chokes with iron powder core ■ SMT power inductors ■ HPI 13, ERU 25 (SMT power inductors) ■ Transformers based on E cores (EF, ER, EV, EHP)
Single-ended flyback converters		<ul style="list-style-type: none"> ■ Transformers based on E cores (EF, ER, EV, EHP) ■ Ring core chokes with iron powder core
Single-ended forward converters		<ul style="list-style-type: none"> ■ Transformers based on E cores (EF, ER, EV, EHP)

General technical information

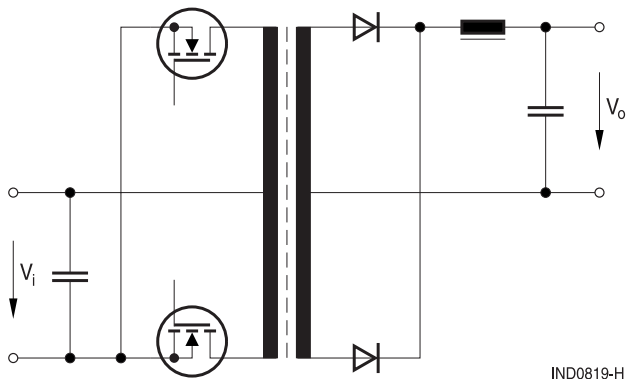
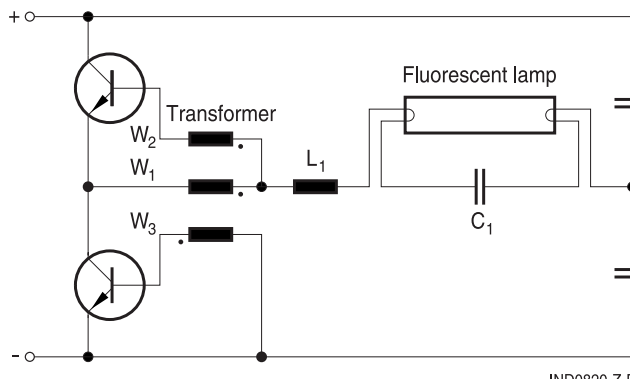
Application	Typical circuit diagram	Components
Push-pull converters	 <p style="text-align: right;">IND0819-H</p>	Transformers based on E cores (EF, ER, EV, EHP)
Electronic lamp ballast devices	 <p style="text-align: right;">IND0820-Z-E</p>	Transformers based on E cores (EFD, ELP, EF)

2.5 Signal processing

Among other things, signal transformers are notable for being able to transform signals in a large frequency range. They are consequently used in particular in high-speed data transmission (e.g. xDSL) for matching and electrical isolation. Innovative materials and a special winding and coil former design result in low losses, good total harmonic distortion, and fulfilling the requirements on creepage and clearance distances.

2.6 EMC applications

For broadband interference suppression, current-compensated chokes with different core shapes are especially suitable, e.g. ring or D cores and powder core chokes.

Apart from use as filters in mains and other power supply lines, such chokes are important for data lines as used in telecommunications engineering, e.g. in NTBAs (ISDN), in line cards in telephone exchanges (digital and analog) and in automotive electronics for FlexRay^{®1)} and CAN bus applications. For FlexRay with a gross data rate of up to 20 Mbit/s, the bus consortium selected the SIMDAD 1812, 100 μ H as its reference type.

Almost all component families are approved in accordance with the main international standards. All chokes for low-frequency mains networks are dimensioned and tested in compliance with applicable EN and IEC standards.

1) FlexRay[®] is a registered trademark of Daimler AG

Inductive components with particularly good RF characteristics are achieved by the use of ungapped cores. The manufacturing methods developed by EPCOS lead to good reproducibility of attenuation characteristics and enable production of high-quality components at an attractive price.

The company's many years of experience guarantee that customers fast obtain an economical solutions to match their EMC problems. Our own EMC laboratory in Regensburg or one of our other European EMC partner laboratories is at your disposal at all times to help with professional advice and in carrying out measurements (see chapter "EMC services").

2.6.1 Propagation of interference

Interference voltage and current can be grouped into common-mode, differential-mode and unsymmetrical:

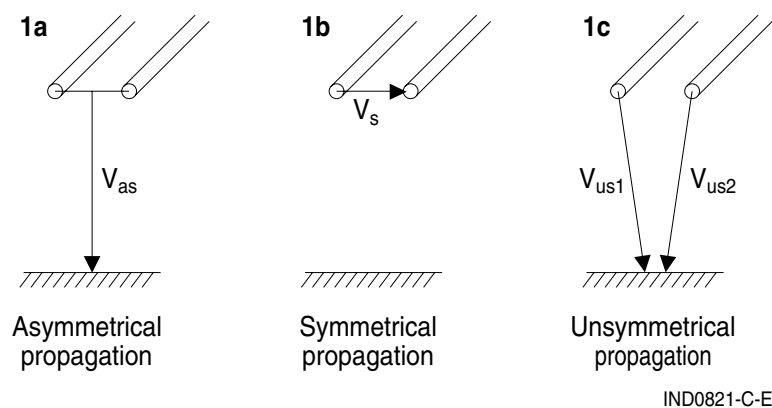

Figure 1 Propagation modes

- 1 (a)** Common-mode (asymmetrical interference):
 - occurs between all lines in a cable and reference potential;
 - occurs mainly at high frequencies (approximately 1 MHz upwards).
- 1 (b)** Differential-mode (symmetrical interference):
 - occurs between two lines (L-L, L-N);
 - occurs mainly at low frequencies (up to several hundred kilohertz).
- 1 (c)** Unsymmetrical interference:
 - This term is used to describe interference between one line and the reference potential.

2.6.2 Characteristics of interference

To choose the correct EMC measures, we need to know the characteristics of the interference, how it is propagated, and the coupling mechanisms. In principle, interference can also be classified by its propagation mode (figure 2). At low frequencies it can be assumed that interference only spreads along conductive structures, at high frequencies virtually only by electromagnetic radiation. In the megahertz frequency range the term coupling is generally used to describe the mechanism.

Accordingly, conducted interferences at frequencies up to several hundred kilohertz is mainly differential-mode (*symmetrical*). At higher frequencies it is mostly common-mode (*asymmetrical*).

General technical information

This is because the coupling factor and the effects of parasitic capacitance and inductance between the conductors increase with frequency.

X capacitors and single chokes offer effective differential-mode insertion loss. Common-mode interference can be reduced by current-compensated chokes and Y capacitors. But this will require a well designed, EMC compliant grounding and wiring system.

The categorization of types of interference and suppression measures and their relation to the frequency ranges is reflected in the frequency limits for interference voltage and interference field strength measurements.

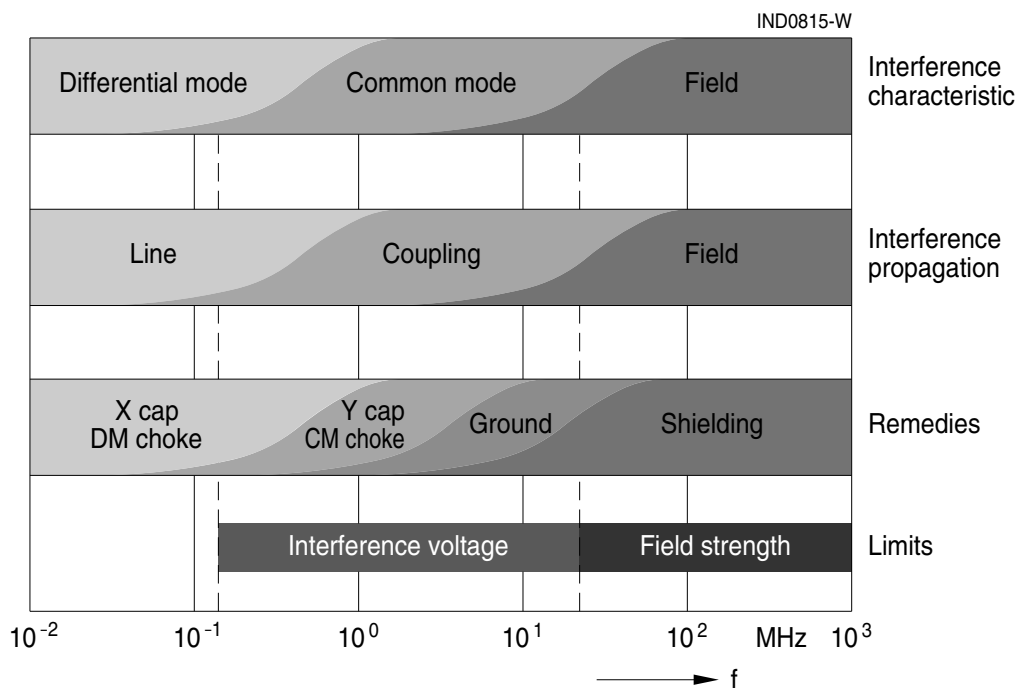

Figure 2 Frequency range overview

DM choke = Iron powder core chokes, but also all single chokes (differential-mode)

X cap = X capacitors

CM choke = Current-compensated chokes (common-mode)

Y cap = Y capacitors

2.7 Safety regulations

When selecting EMC components – in particular for power line applications – the safety regulations applicable to the relevant equipment must be observed.

General technical information

3 Safety approval marks

Now that the various national standards in Europe have been superseded, chokes are only tested to the current European standard EN 60938-2. The approval from a certification body is valid in all EU member states without further testing. The chokes then bears the safety approval mark issued by the certification body. Our chokes are approved by VDE and thus bear the ENEC mark with identification number 10 of the VDE Certification Institute.

Many of our chokes bear the UL approval mark for use on the North American market.

Safety approval marks granted for chokes are listed in the data sheets.

At the test organizations, our chokes are listed under the following file numbers:

Certification institute	File number	Standard
VDE	40405-4710-*	EN 60938-2
UL	E70122	UL 1283

Europe:



ENEC 10



VDE

North America:



UL
USA

General technical information

4 Electrical characteristics

4.1 Rated voltage V_R

The rated voltage V_R is the maximum AC or DC voltage that can be continuously applied to the component at temperatures between the lower category temperature T_{min} and the upper category temperature T_{max} .

4.2 Test voltage V_{test}

The test voltage V_{test} is the AC or DC voltage that may be applied to a component for the specified test duration in the course of final inspection (100% end of line testing). This test may be repeated once as an incoming goods inspection test.

4.3 Rated current I_R

The rated current I_R is the AC or DC current at which the component may be continuously operated under nominal operating conditions.

For components with one, two or three lines, the rated current is specified for simultaneous flow of a current of this value through all lines.

During AC operation, higher thermal loads may be caused due to waveforms deviating from a pure sinewave. Where necessary, such cases must be taken into consideration.

4.4 Current derating I_{op}/I_R

At ambient temperatures above the rated temperature stated in the data sheet, the operating current must be reduced according to the derating curve.

4.5 Saturation current I_{sat}

The maximum permissible DC with inductance decrease $\Delta L/L_0$ of approx.10% (or as specified).

4.6 Overcurrent

The rated current may be exceeded briefly. Details on permissible currents and load duration can be provided on request.

4.7 Pulse handling capability

Saturation effects (e.g. in the ferrite cores used) may occur when high-energy pulses are applied to components, and these may lead to impaired interference suppression. The maximum permissible voltage/time integral area is used to characterize the pulse handling capability of chokes. For standard components a range from 1 to 10 mVs can be assumed. More specific data can be provided on request.

4.8 Rated inductance L_R

The rated inductance L_R is the inductance used to designate the choke, as measured at the frequency f_L .

4.9 Stray inductance L_{stray}

The stray inductance L_{stray} of a current-compensated choke is the inductance measured through both coils when a current-compensated choke is shortcircuited at one end. This affects symmetrical interference.

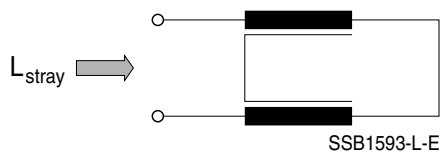

Figure 3 Stray inductance

4.10 Inductance decrease $\Delta L/L_0$

The inductance decrease $\Delta L/L_0$ is the drop in inductance at a given current relative to the initial inductance L_0 measured at zero current. The data sheets specify this as a percentage. This decrease is caused by magnetization of the core material, which is a function of the field strength, as induced by the operating current. Generally the decrease is less than 10%.

4.11 DC resistance R_{typ} , R_{min} , R_{max}

The DC resistance is the resistance of a line measured using direct current at a temperature of 20 °C (unless otherwise specified in the datasheet), whereby the measuring current must be kept well below rated current.

R_{typ}	typical value
R_{min}	minimum value
R_{max}	maximum value

4.12 Winding capacitance, parasitic capacitance C_p

Parasitic capacitances (C_p), which impair the RF characteristics of components, are related to component geometry. These capacitances may affect the two lines mutually (symmetrically) as well as the line-to-ground circuit (asymmetrically). The design of all EMC components supplied by EPCOS minimizes parasitic effects. The components consequently exhibit excellent interference suppression characteristics right up to high frequencies.

4.13 Resonant frequency f_{res}

Interaction between the parasitic capacitance C_p and the inductance L of the component produces a parallel resonant circuit. At the self-resonant frequency the energy consequently oscillates between the internal elements capacitance and inductance, and there is virtually no further energy intake. The component acts like a high resistance. At higher frequencies the component works capacitively. The component should therefore be operated well below resonant frequency.

4.14 Quality factor Q

Quality factor Q is the quotient of the imaginary part of the impedance divided by the real part.

4.15 Measuring frequencies f_Q , f_L

f_Q is the frequency for which the quality factor Q of a choke is specified.

f_L is the frequency at which the inductance of a choke is determined.

4.16 Sensitivity

This indicates in mV/μT how high the open-circuit voltage induced in a transponder coil will be in a magnetic field.

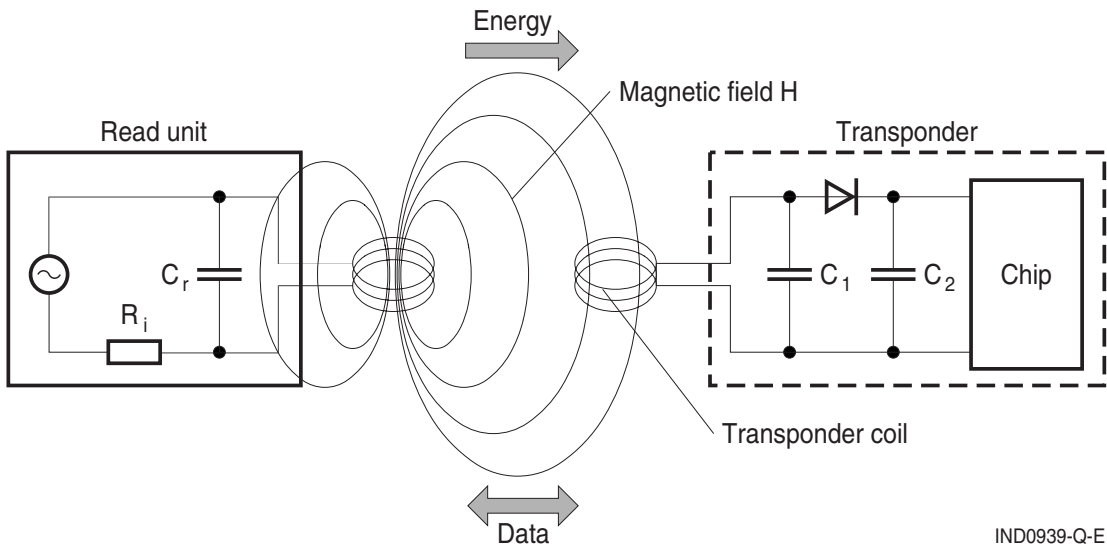

Figure 4 Test setup for sensitivity measurement

4.17 Insertion loss

Insertion loss is a criterion for the effectiveness of interference suppression components, measured by using a standardized circuit (figure 5).

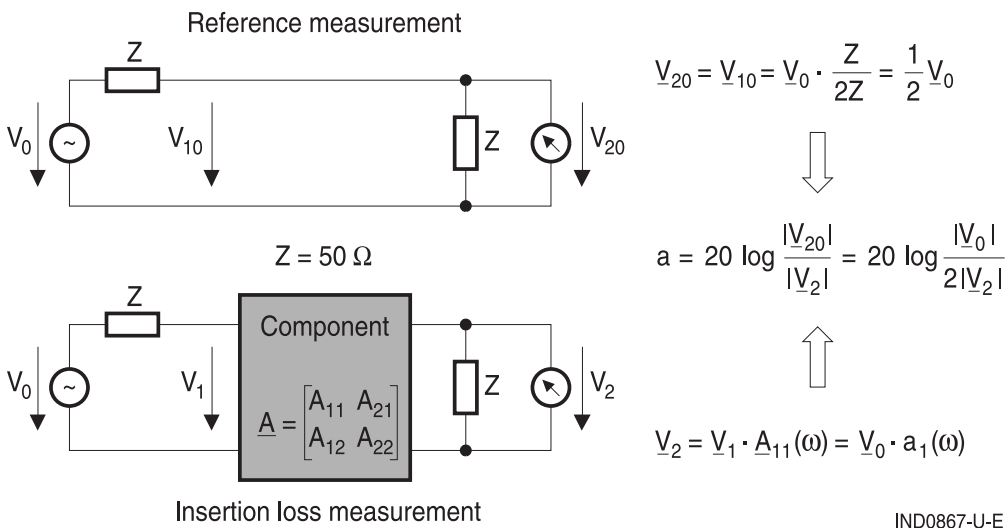

Figure 5 Definition of insertion loss

The input terminals of the component under test are connected to an RF generator with impedance Z (usually 50 Ω). At the output end of the component, the voltage is measured using a selective voltmeter having the same impedance Z. The insertion loss is then calculated from the quotient of half the open-circuit generator voltage V₀ and the component output voltage V₂.

5 Temperature behaviour of closed ferrite cores

EPCOS defines all electrical values and tolerances at 20 °C and the respectively specified temperature. The use of chokes with cores made of soft magnetic materials means that component characteristics depend on the temperature behaviour of the selected core material. So deviant magnetic properties (e.g. permeability, saturation) of the core material will result at other temperatures. This will lead to different inductance values, insertion loss or saturation properties of the component. Mainly at high temperatures the saturation limit will decrease and the choke will be saturated (even if the surge current is not changed compared to room temperature), and the inductance value will decrease dramatically. The shift in behaviour of the components due to temperature must be checked in the equipment of the customer for critical operating conditions. In an example for insertion loss, the temperature dependence of different ferrite materials (NiZn and MnZn) with different permeability is shown at the temperatures -40 °C, +20 °C and 125 °C.

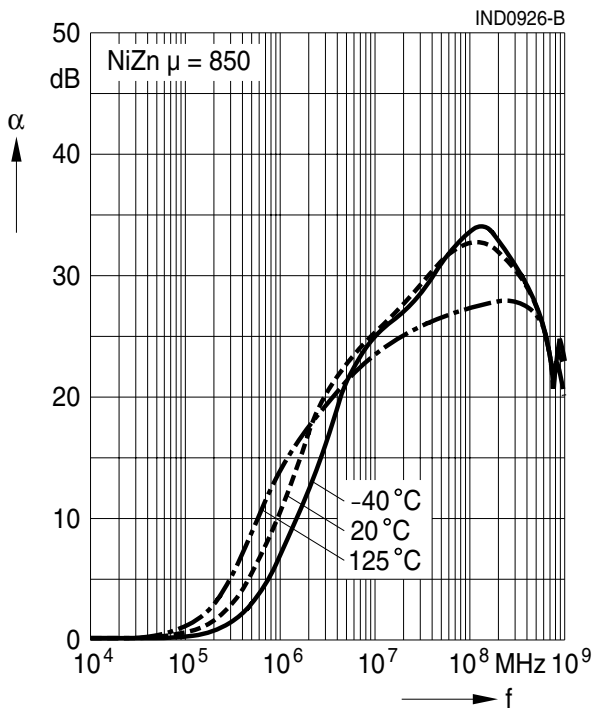

Figure 6 Insertion loss α (common-mode) measured on B82793S0513N201

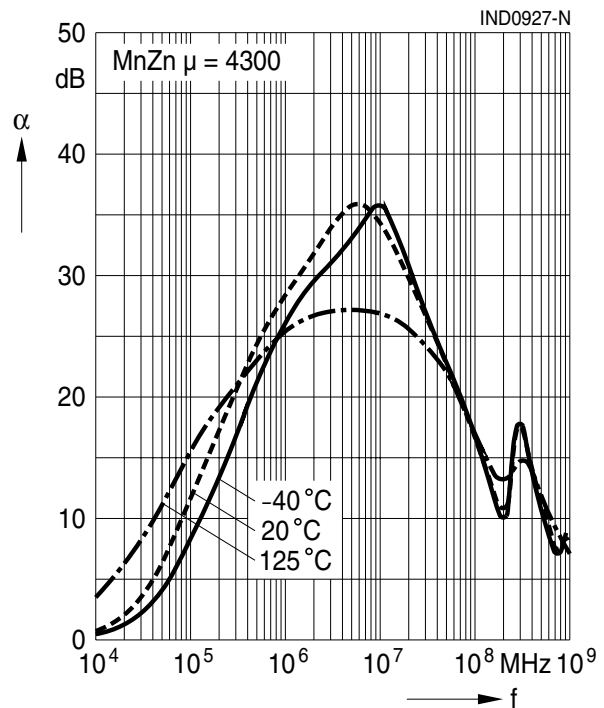

Figure 7 Insertion loss α (common-mode) measured on B82793C0474N215

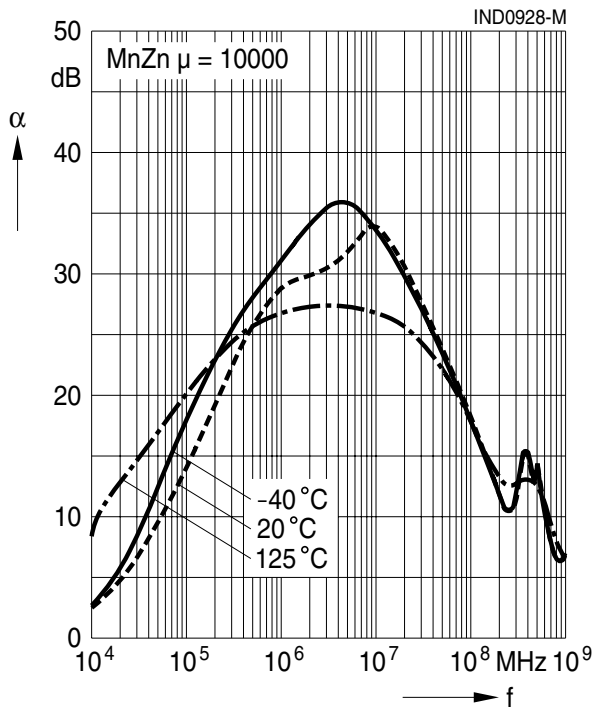

Figure 8 Insertion loss α (common-mode) measured on B82790C0105N240

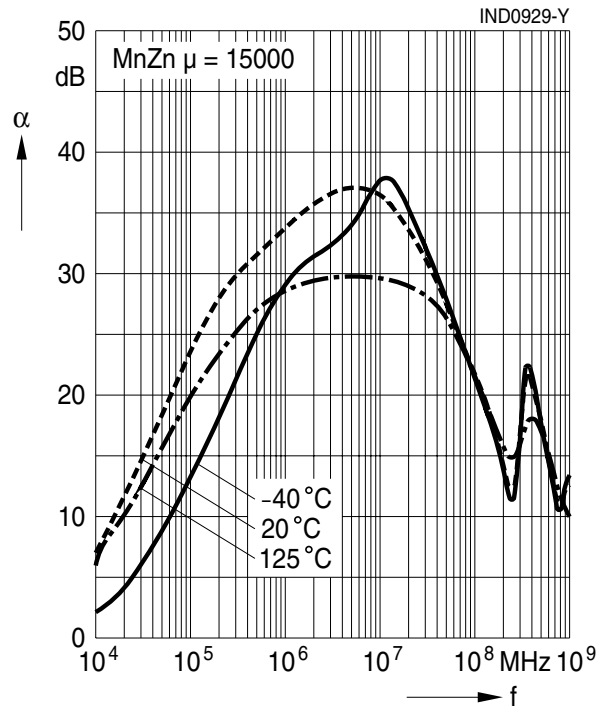

Figure 9 Insertion loss α (common-mode) measured on B82793C0225N265

6 Mechanical properties

6.1 Potting (economy potting, complete potting)

We distinguish between economy potting and complete potting.

Economy potting is used to fix the core and windings in the case and the windings on the core. This is an economical technique that enables a single resin casting procedure to be used. Most chokes supplied by EPCOS are manufactured in this way.

Complete potting is only required when the thermal conductivity of economy potting is not adequate or if the customer has special demands. Complete potting requires several process steps to ensure complete embedding of the core and windings.

Economy potting

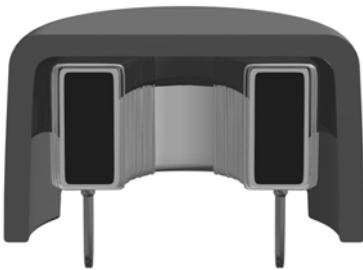

Complete potting

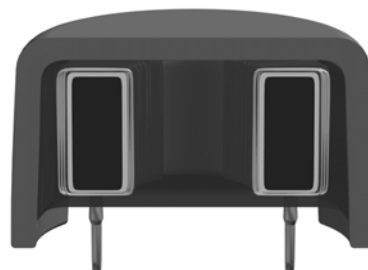

6.2 Types of winding

EPCOS uses different types of winding to suit the respective technical requirements:

- single-layer winding
- multilayer winding
- random winding

The different types of winding lead to different inductance characteristics, especially at high frequencies.

Single-layer winding:

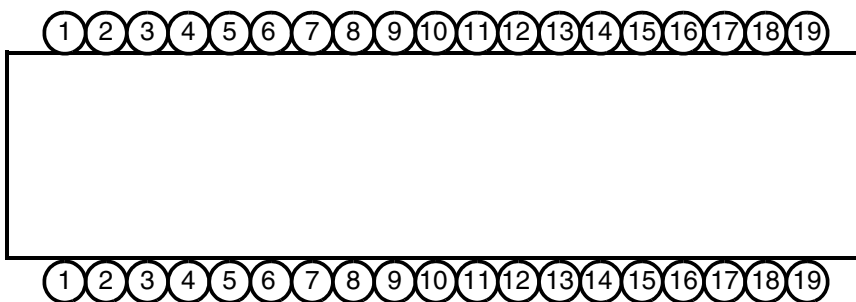

Compared to other types of winding, this leads to the lowest possible capacitances and thus the highest resonant frequencies.

General technical information

Multilayer winding:

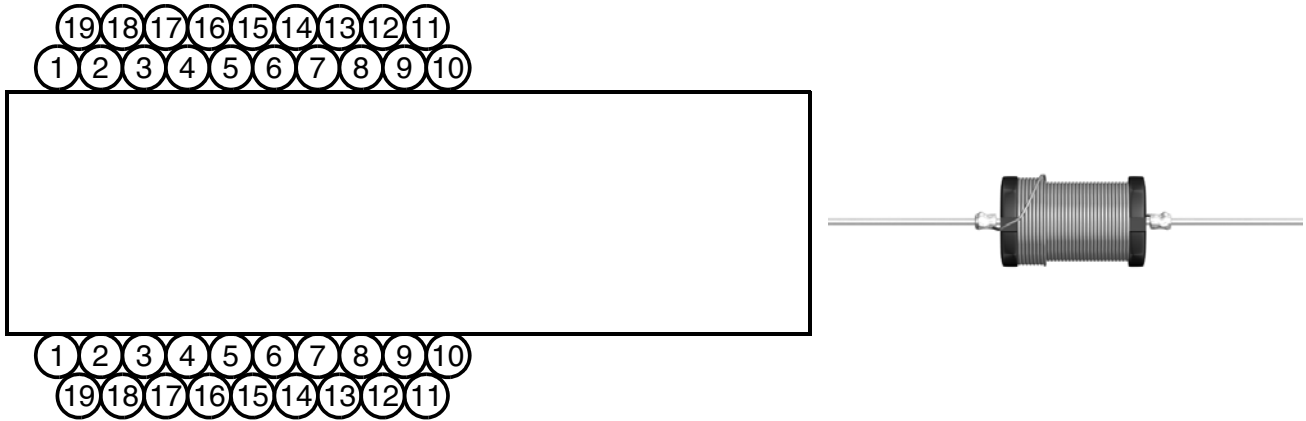

Compared to other types of winding, this type leads to the highest capacitances and thus the lowest resonant frequencies.

Random winding:

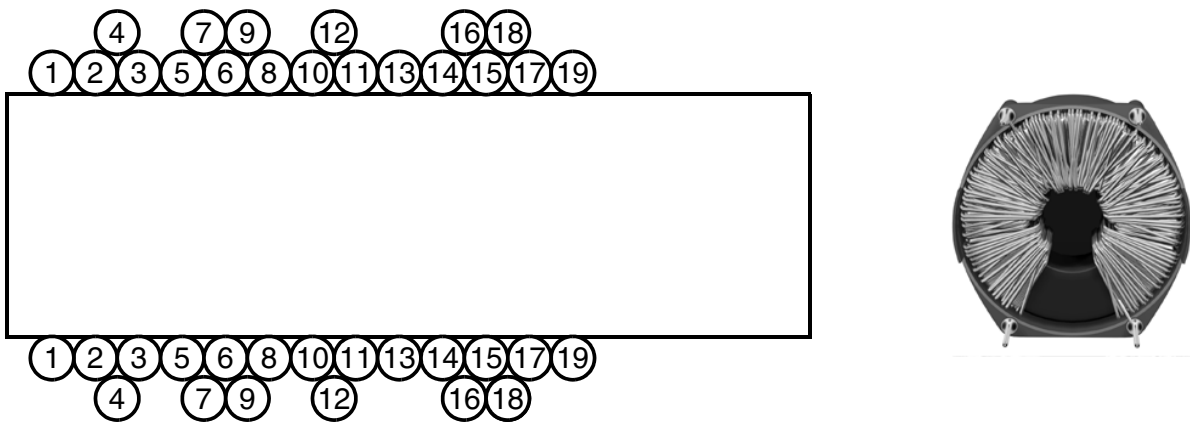

This method of winding a coil does not permit the final position of a turn to be predetermined exactly. The cross-section clearly shows a disorderly, random arrangement of the turns. This leads to the parasitic capacitances being only minimally greater than those achieved by single-layer winding, and the resonant frequencies are equal to those achieved by single-layer winding.

6.3 RF characteristics of various types of winding

Figure 10 shows impedance as a function of frequency for two chokes of the same inductance. One choke has a two-layer winding, the other is randomly wound and has a considerably higher first resonant frequency. Spurious resonances are very much higher than 10 MHz. Impedance at frequencies above the first resonant frequency is approximately five times higher. This leads to better interference suppression at high frequencies.

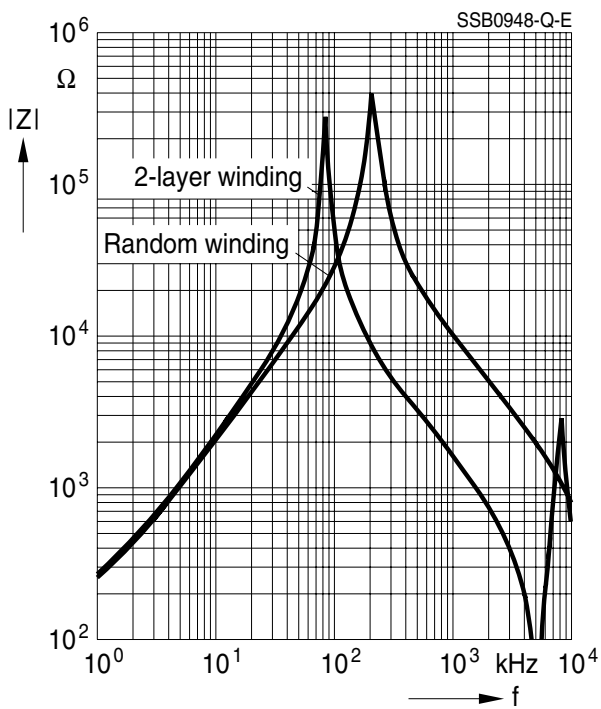

Figure 10 Impedance $|Z|$ versus frequency f , comparison between two-layer and random winding

The RF characteristics of all chokes supplied by EPCOS are reproducible, as the winding processes that we have developed for single-layer, multilayer and random winding ensure that the characteristics of the manufactured inductors show very little variation.

Reproducibility of electrical characteristics of chokes is mainly determined by the manufacturing process. At EPCOS coils are wound mainly by automatic machines (either fully or semi-automated). This permits even complicated winding patterns to be created in large production runs with very little variation in product characteristics.

7 Climatic characteristics

7.1 Upper and lower category temperature T_{\max} and T_{\min}

Upper category temperature T_{\max} and lower category temperature T_{\min} are the highest and lowest permissible ambient temperatures, respectively, at which a component can be operated continuously.

7.2 Rated temperature T_R

Rated temperature T_R is the highest ambient temperature at which a component may be operated under nominal conditions.

7.3 Reference temperature for measurements

Unless otherwise specified in data sheets, the reference temperature for all electrical measurements is 20 °C to IEC 60068-1.

7.4 IEC climatic category

IEC 60068-1, Appendix A, defines a method of specifying the climatic category by three groups of numbers delimited by slash characters.

Example: 55/125/56

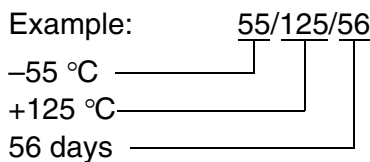

-55 °C
+125 °C
56 days

1st group of numbers:

Absolute value of the lower category temperature T_{\min} as test temperature for test Aa (cold) to IEC 60068-2-1

2nd group of numbers:

Absolute value of the upper category temperature T_{\max} as test temperature for test Ba (dry heat) to IEC 60068-2-2
test duration: 16 h

3rd group of numbers:

Stress duration in days.

Test Cab (damp heat, steady-state) to IEC 60068-2-3
at (93 +2/-3)% relative humidity and 40 °C ambient temperature

8 Storage conditions in site and sales warehouses

8.1 Purpose/aim

This guideline regulates storage conditions for finished goods in site warehouses and sales warehouses (those of EPCOS sales companies) to assure that delivered products have the same processing properties as when put into storage.

8.2 Ambient conditions

For all components the following storage conditions apply:

- storage is in the original package in a non-aggressive atmosphere,
- storage temperature should not be less than -25 °C (-13 °F) and not exceed $+40\text{ °C}$ ($+104\text{ °F}$),
- relative humidity should be 75% as an annual average and 95% on max. 30 days per annum, condensation is not allowed. To limit humidity to max. 70%, if necessary, vacuum packages (dry packs) are being used.

8.3 Shelf life

The shelf life of electronic components is limited by material characteristics or decreasing solderability of the terminations.

All components can be processed as specified within two years from date of production. To allow for enough storage time with the customer, components should be delivered no later than at least one year prior to the end of the warranty term of two years.

8.4 Legal requirements

Any additional, local legal regulations regarding warehousing/storage conditions have to be followed accordingly.

9 Solderability

All EPCOS inductors in surface-mount technology can be reflow soldered.

For

- SMT inductors (SIMID series),
- SMT power inductors,
- SMT data line chokes with I core
- transponder coils
- transformers

the recommended soldering profile for lead-free soldering is shown below. The soldering conditions are listed in the tables on the following pages.

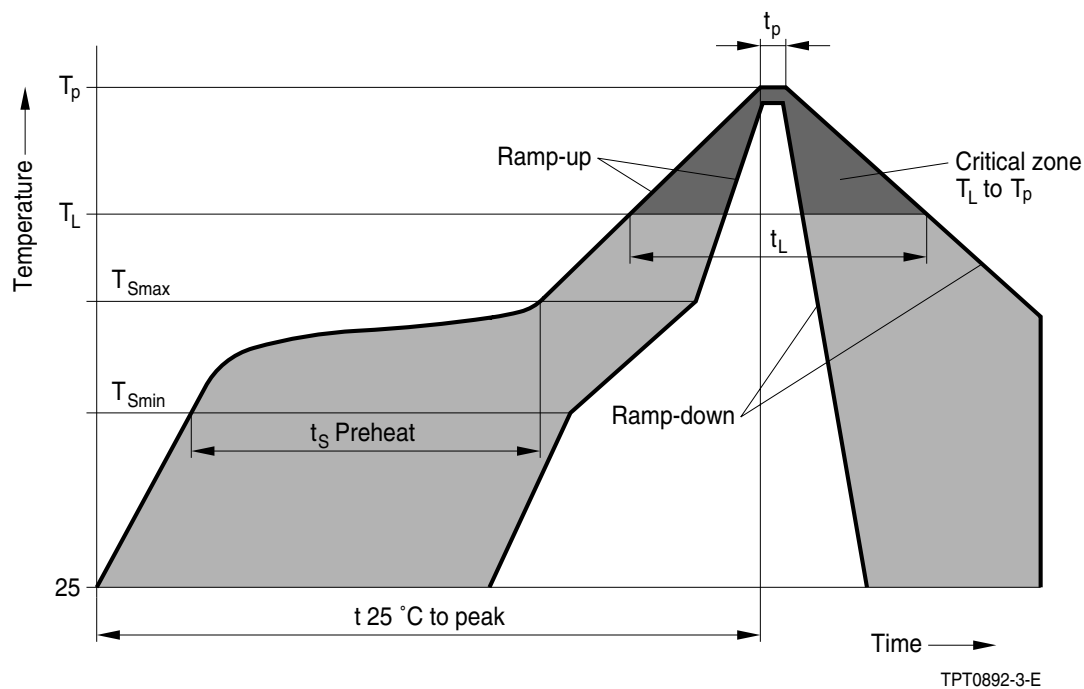

Figure 11 Recommended soldering profile for lead-free soldering based on JEDEC J-STD-020C

General technical information

Recommended profile

Series	Pre-heating		Heating		Peak		Time t 25 °C to peak	No. of cycles
	Temper- ature ¹⁾ T _{Smin} – T _{Smax}	Time t _S	Temper- ature ¹⁾ T _L	Time t _L	Temper- ature ¹⁾ T _P	Time t _S		
B82499A B82494A	150 – 190 °C	120 s	217 °C	90 s	245 °C	10 s	300 s	2
B82498F (AgPdPt) B82498B (AgPdPt)	150 – 190 °C	120 s	217 °C	90 s	245 °C	20 s	300 s	2
B82496C B82498F (Au-plated) B82412A B82422T/H/100/A B82432T/C/A B82442A/H/T	150 – 190 °C	120 s	217 °C	90 s	245 °C	20 s	300 s	2
B82462A/G B82464A/G/P B82470A B82471A/B B82472P B82473A B82475A B82476A/B B82477D/P B82479A/G B82559								
B82464Z B82466G B82467G B82468A B82469G B82472G B82477G	150 – 190 °C	120 s	217 °C	60 s	245 °C	10 s	300 s	2
B82450A*A	150 – 190 °C	120 s	217 °C	90 s	245 °C	20 s	300 s	2
B82788C0/S0 B82789C0/S0								
B783** B784** B785**	150 – 190 °C	110 s	217 °C	90 s	240 °C	20 s	300 s	2

Recommended solder paste: Sn95.5Ag3.8Cu0.7

1) According to JEDEC and IEC temperatures measured on top side of component.

General technical information

Limit profile (max. values)

Series	Pre-heating		Heating		Peak		Time t 25 °C to peak	No. of cycles
	Temper- ature ¹⁾ T _{Smax}	Time t _s	Temper- ature ¹⁾ T _L	Time t _L	Temper- ature ¹⁾ T _P	Time t _s		
B82499A B82494A	200 °C	120 s	217 °C	105 s	260 °C	10 s	300 s	2
B82498F (AgPdPt) B82498B (AgPdPt)	200 °C	120 s	217 °C	105 s	260 °C	20 s	300 s	2
B82496C B82498F (Au-plated) B82412A B82422T/H/100/A B82432T/C/A B82442A/H/T	200 °C	120 s	217 °C	105 s	260 °C	40 s	300 s	3
B82462A/G B82464A/G/P B82470A B82471A/B B82472P B82473A B82475A B82476A/B B82477D/P B82479A/G								
B82464Z B82466G B82467G B82468A B82469G B82472G B82477G	190 °C	120 s	217 °C	60 s	260 °C	10 s	300 s	2
B82450A*A	200 °C	120 s	217 °C	105 s	260 °C	40 s	300 s	3
B82788C0/S0 B82789C0/S0								

Recommended solder paste: Sn95.5Ag3.8Cu0.7

1) According to JEDEC and IEC temperatures measured on top side of component.

10 Traceability/barcode label

On the product packing label (standard label) we include barcode information in addition to plain text. This provides above all a faster and more secure means of checking identification for the customer.

<p>EPCOS SMT-INDUCTOR 10X10 47 UH 1,4 A RoHS - compatible</p> <p>(1P) PROD ID: B82464G4473M V 2</p>  <p>(9K) PROD ORDER NO: (D) D/C: 080506</p>  <p>(T) BATCH NO: 0009022880 (Q) QTY: 750</p>  <p>MADE IN HUNGARY</p>	<p>Product, size, inductance, current</p> <p>(1P) Ordering code</p> <p>(9K) Product order number</p> <p>(D) Date of manufacture (YYWWDD)</p> <p>(T) Batch number</p> <p>(Q) Quantity</p>
--	---

IND0930-X-E

Figure 12 Example of a barcode label of SMT power inductors